

ENJOY THIS COPY
compliments of



The
The MQL logo is rendered in a vibrant green color. The letters "M", "Q", and "L" are thick and blocky. The "M" is partially overlaid by a stylized leaf. The "Q" has a small tail that ends in a series of dots. The "L" is also thick and blocky.
HANDBOOK

A guide to machining with
Minimum Quantity Lubrication

Tim Walker

Dedication: To Wally Boelkins who was championing MQL well before it even had a name, and who wanted to get it all in writing before he retired but found there was always one more person to talk to and one more place to visit.

For more information contact Unist at:

1-800-253-5462 (US & Canada)

1-616-949-0853 (international)

Email: salesupport@unist.com

unist.com

The MQL Handbook
Copyright © 2015 Unist, Inc. V1.0.7

Table of contents

What is Minimum Quantity Lubrication?	1-5
Introduction.....	1
Where is MQL practical?	5-7
Open machines	5
Machines that are used intermittently.....	6
Micromachining.....	6
High-speed machining	6
General machining.....	6
What about the mist?	7-8
Process and ecosystem.....	9-10
How does MQL work?	10-17
Heat management	10
Less is more.....	15
More is better	16
The sweet spot	17
MQL equipment.....	17-31
The applicator.....	18
Moving the fluid	20
The outputs	22
Internal or external?.....	23
The lubricant	28
Types of MQL fluids.....	29
Wetting:.....	30
Viscosity.....	30

Tools and tool holders..... 31-35
 The machine33
 Emission extraction systems34

How to implement MQL 35-44
 Training35
 Considerations when setting up the applicator36
 Rules of thumb for external nozzles39
 Rules of thumb for MQL fluids43

Some fluids that are not suitable for MQL..... 45-50
 Material.....45
 Tools47
 Chips49

What does moving to MQL mean in terms of overall effectiveness?..... 50

Conclusion 51

Appendix 1: Resources 51

Appendix 2: Examples of successful MQL settings and results..... 52-54

Sources..... 55-56

What is Minimum Quantity Lubrication?

Introduction

Minimum Quantity Lubrication (MQL) is just what the name implies. MQL uses a very small amount of a fluid to reduce the friction between a cutting tool and the work piece. The exact amount for “minimum” varies depending on who you ask. The German DIN specification puts it up to 50 mL/hour of lubricant (1.7 oz./hour), and, in exceptional cases, up to 150 mL/hour (5 oz./hour).¹ Other studies have put the cap at 500 mL/hour (17 oz./hour). The amount is somewhat subjective and will depend greatly on the materials, processes, and the tools. Some materials have more natural lubricity than others, some processes are better able to get the fluid to the right place, and bigger tools need more lubricant than smaller ones. But as a general rule of thumb, 5 to 80 mL/hour (0.2 to 2.5 oz./hour) on tools less than 40 mm (1.57”) in diameter seems to keep chips dry and gives good results. No matter where you fall in this range, it is much less than the 30,000-60,000 mL/hour (8 to 16 gallons/hour) typically used with flood coolants!

MQL works best in cutting applications such as sawing, milling, turning, and drilling. It is not as effective in abrasive operations such as grinding, honing, and lapping where the fluids are needed to flush the resulting swarf away to avoid gumming.

There are many advantages to using less fluid. From an economic perspective, MQL simply costs less. Many are surprised to learn that the savings are not simply from buying less fluid. Although MQL fluids typically cost substantially more per gallon, less than 1/10,000 of the amount of fluid is used. This makes the cost per machined volume much less. MQL is considered a near-dry process, with less than 2 percent of the fluid adhering to the chips. This is not the same as dry machining where no fluid is used, but both share the

characteristic of needing no reclamation equipment. This eliminates investments into sumps, recyclers, containers, pumps, and filtration devices.

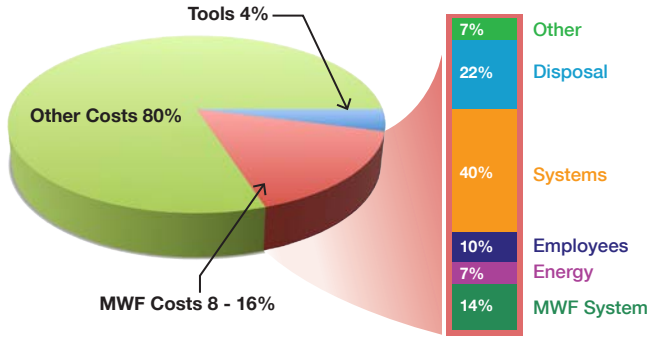

Figure 1: Machining cost breakdown

Furthermore, there are no costs for cleaning and drying the chips before their disposal or cleaning the work pieces prior to the next process.

The exact amount of savings will vary by plant, but industry estimates are that from 8 to 16% of total operation costs are related to metalworking fluids (MWF's)² and MQL will substantially cut these costs.

The extreme reduction of fluid greatly reduces health hazards caused by metalworking fluid emissions both into the air and on the skin of employees. When done properly, MQL fluids do not spread throughout the work area. They do not get into the electrical components of the machine nor dissolve the paint off of surfaces. This makes the whole shop cleaner and extends the life of the machines.¹²

Although it may seem counter-intuitive, many shops see substantial increases in tool life. The reasons for this will be explained in the section How does MQL work?, but the increase has been up to 500%! In addition to the improvement in tool life, it usually results in better surface finishes too.

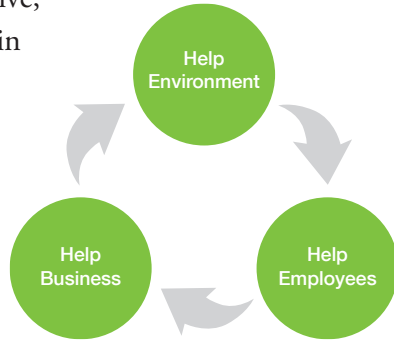

Figure 2: MQL virtuous cycle

Lastly, in comparison to flood coolant, MQL is better by far for the global environment. Its reduction in waste and its environmentally friendly fluids make it a very eco-friendly process. Of course, all of these relate to each other. What is really exciting about moving to MQL is the virtuous cycle it starts. All the elements work with each other to reinforce the positive results displayed in Figure 2.

The German Ministry of Education and Research (BMBF) did a 3-year project called “Forschung für die Produktion von Morgen” or “Research for Tomorrow’s Production.” In this study, they looked at MQL and other “dry machining processes” (defined as those that leave less than 2% fluid residue on the chip). Fifty-eight studies were done involving several companies and many different materials. The involvement of large companies such as Bosch and Daimler-Chrysler allowed insights gleaned from the study to trickle down to small and medium sized companies who could not afford to do the research themselves. Several of their findings are used in this booklet, and the table in Figure 3 is a sample of the MQL specific results that were found.

Business	Product	Material	Process	Results
Automotive Supplier	Throttle Housings	GD-ALSi-12Cu4	Milling, Drilling, Reaming	Reduction of component costs by 8%
Commercial Printing Press Manufacturer	Drilled And Tapped Strips	Ck45	Milling, Drilling, Threading, Reaming	Shortened the process time from 10.49 min to 7.32 min
Automotive Manufacturer	Gears, Car Gearboxes	Case-Hardened Steel (20MoCr4)	Shaping	Environmental protection Reduction of component costs by approx. 5%
Tool And Die Shop	Tools	Tool Steels	Milling, Turning	80% reduction of maintenance and cleaning work, better surface quality, shorter processing times
Pneumatic Cylinders Manufacturer	Connector	A1 Die Cast GD-ZnAl4Cu1	Tapping, Grooving	Cleaner machine environment, metalworking fluid cost savings, less maintenance and cleaning work, higher cutting values
Aviation	Aircraft Components	AL Forged Alloy	Milling	Environmental protection, cleaner machine environment, low costs for machines
Power Plant Manufacturers	Turbine Blades	X22CrMoV 12.1, CrNi Steels	Milling	Tool life tripled

Figure 3: Results of using MQL⁴

MQL is not as widely known or understood in North America. The stronger environmental laws in European countries have led to a far more widespread adoption there. This is bad news for U.S. manufacturers because their international competition has taken the time, learned the hard lessons, and is now reaping the competitive advantages of MQL. Doug Watts, the CTO of MAG Americas wrote in the AMT's TIC views column that by failing to investigate MQL, American manufacturers may be missing "the next real technology opportunity to restore American manufacturing leadership." Of course the good news is that we do not need to go through the difficult learning process these early adopters did. Instead we can learn from their experience. So why look at MQL? Clean floors. Clean parts. Healthier employees. Longer tool life. More machine up-time. Better profitability. These are just a few of the reasons. What more do you need?

Where is MQL practical?

There are some places where MQL is normally the best choice. This includes open machines, machines that may sit unused for long periods of time, micromachining, and in high-speed machining processes.

Open machines

In open machines, flood cooling is just plain messy. So messy it is often not done at all. Instead, the trusty squirt bottle is used or cuts are made dry. On saws or other systems where a flood system is used, the coolant ends up running down (and through, in the case of pipes or tubes) the work piece and all over the floor. In most of these cases, an MQL system will increase the tool life without any mess.

Machines that are used intermittently

For the machine that sits unused for periods of time, MQL eliminates emulsions that go rancid and can end up acting as a bacteriological cesspool, complete with foul odors and related health hazards. With MQL the lubricant is clean and stays that way until ready to use.

Micromachining

In micromachining, most conventional processes such as turning, milling, and drilling can benefit from MQL. Successful micro-drilling has been reported for holes with a 10:1 depth to diameter ratio. MQL can significantly reduce built-up edges, burr size and cutting force, and thus improve tool life. Depending on which cutting fluid is used and how it is applied, researchers have found that MQL performs at least as well as flood cooling and in many cases extends the tool life 3 to 10 times. There is not, as of this writing, any published paper where inferior results were found using MQL over dry or flood cooling.³

High-speed machining

Several studies have shown that in High-speed Machining (HSM), MQL works better than dry machining or flood cooling. The dynamics are not fully understood, but the basics are that the MQL output is better able to penetrate the air barrier around the tool and the tool work piece interface than flood coolants. This results in better lubricity than either dry or flooding and, therefore, does a better job.

General machining

MQL works well in most general machining operations. Many of the benefits will be seen in any implementation: lower fluid use, cleaner machines, better employee work environment, cleaner chips, and greener machining. Many shops choose to implement MQL for these reasons alone.

Longer tool life is not always a benefit that MQL can provide. This is, typically, because MQL is more process sensitive than flood cooling. This is discussed in more detail later in this booklet, but to achieve gains in tool life, the process must be in the “sweet spot” where the lubricity and/or cooling of MQL keeps the tool in a temperature zone that works well for both the tool and the material being cut.

What about the mist?

Although commonly called a mist system, machining with minimum quantity lubrication has been shown to produce fewer emissions than flood cooling. It is, in fact, a low-emission process. Unfortunately, when starting with MQL, many shops think that more is better so they blast as much air as possible through the MQL nozzles and literally create a fog or mist of lubricant in the air. This is not MQL! A properly adjusted MQL system uses just enough air velocity to drive the lubricant to the tool, not enough to drive it around the block!

MQL has fewer emissions and is safer than standard flood coolant. Numerous studies measured the exposure of machine operators working around and inside of the machine as well as the more static levels just at the machine’s control panel. In the main study, which was conducted by the German government, the baseline was done using flood coolants. MQL was found to never have higher levels for aerosols, and the concentrations in more than 95% of the areas were less than half of the flood coolant baseline values.⁴

Figure 4 shows the comparison done on a lathe set up for machining steel. The metal working fluid emissions produced were measured for both flood lubrication and minimum quantity lubrication. Measurements were taken on the operator, at the machine itself, and inside the machine.

The results speak for themselves. The benefits of lower emissions are not only seen when the work is being machined. With MQL, the parts and chips come out dry; there are no evaporative emissions and no skin contact with metal working fluids when handling or storing the cut or machined parts.

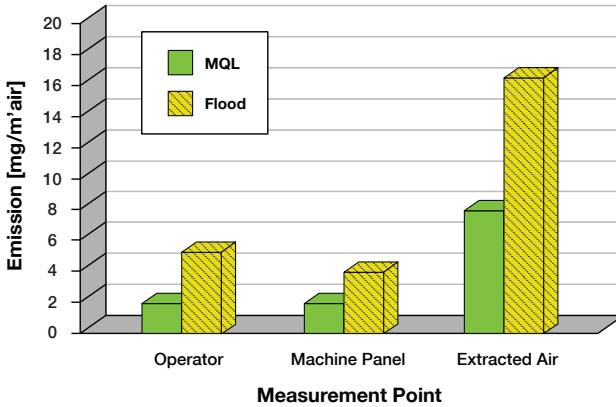

Figure 4: Comparing flood vs. MQL emissions

MQL offers many occupational safety advantages over water-miscible MWFs. In particular, when MQL is done with vegetable-based cutting oils, it is far safer for employees. Not only are there fewer emissions to worry about, but vegetable oils are naturally removed from the lungs in days instead of the months required for petroleum based fluids. The body's removal method is also different (expectoration versus absorption) and studies indicate they cause no long term damage to lungs or skin.⁵ Instead of petroleum emulsions, only small amounts of clean ester-based or fatty-alcohol-based lubricants are used. Unlike emulsions, there is no need for system cleaners, biocides and fungicides that are harmful to skin and health. Ester oils, and especially fatty alcohols, can, however have a degreasing effect that dries skin with prolonged direct contact. This does not necessarily mean that emission is not needed. As discussed later in this book, proper emission control ensures the removal of any extra emissions and the metal particles generated when cutting.

Process and ecosystem

MQL is more process sensitive than flood-cooling. There is a “sweet spot” where MQL works well and optimal results are achieved. The good news is that this zone is often fairly large and overlaps the machining settings used with flood coolants. In this case, just changing from flood coolant to MQL and leaving all the other cutting parameters the same will yield the full benefits of MQL. However, in some cases, changes have to be made to the machining process to get it into the sweet spot. This may include changing the feed and speeds (even increasing them), changing tool material and/or geometries, and varying the amount of lubricant applied.

Since getting the fluid in the right location is so important to MQL, nozzle position and selection is critical. With any single MQL output, the front of the tool will block, or shadow, the lubricant from coating the back. This leaves an area on the tool that not effectively lubricated. Depending on the operation and the direction of cut this may be problematic.

In operations where the tool is embedded in the work, such as turning or drilling, getting an external nozzle to apply fluid where the cut is taking place can be challenging. Internally-fed tools and specialty nozzles are often more appropriate than a conventional style nozzle.

Chip evacuation also needs to be considered. If the flood coolant is used to wash away the chips, when the flood coolant goes, the chips will stay. Compressed air, gravity, vacuums, tool geometries and several other techniques are available to aid with chip removal. Choosing the best one for your operation is important to maximize the success of an MQL implementation.

Optimization of the MQL ecosystem is more practical for jobs that are repeated or that are run for a long time. This allows the cost of the initial learning to be spread over more time. When MQL is used for short, one-off jobs it is often done for the cleanliness and not the tool life. Adopters of MQL in a job-shop environment should know that when the job does not fall in the MQL sweet spot, their tool life may be negatively affected.

The section How to implement MQL will go into detail on many of these items. But in short, maximizing tool life requires the machining ecosystem be made compatible with MQL technology. This includes ensuring that the machining processes are appropriately adjusted and monitored.

How does MQL work?

Heat management

In metal machining, the metal is removed by the cutting edge of a tool, which shears off a chip from the work piece. The energy used in deforming the metal is released, mostly in the form of heat, in the primary and secondary shear zones (shown in Figure 5).

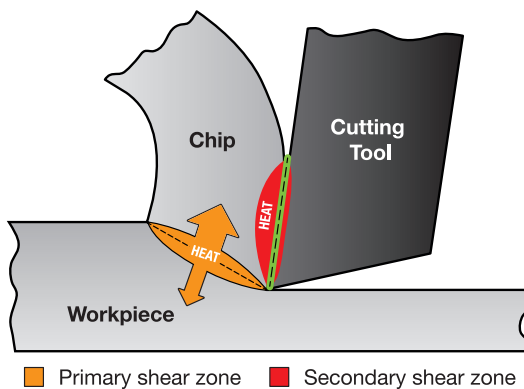

Figure 5: Heat generation in metal cutting

The energy released in the primary shear zone cannot be avoided. It is a result of the molecular bonds being broken on the work piece. Some of the heat goes into the work piece and the rest into the chip. The friction - and resulting heat - between the tool and the work piece in the secondary shear zone causes both the tool and the chip to warm. The heat in this zone is one of the largest contributors to premature tool wear. MQL, properly done, greatly reduces this heat by lubricating the chip-tool interface.

Not too surprisingly, the goal of a coolant system is to cool, or remove, the generated heat. This is because of the relationship between tool life and temperature, as shown in Figure 6.

As Figure 6 clearly shows, the cooler the cutting tool the longer it lasts. But this is really only part of the story. Over the last few years, a great deal of research has been done in dry machining and in MQL. As a result, tool companies have created tools with special coatings and geometries that are made to work at higher temperatures and help keep the heat in the chip.

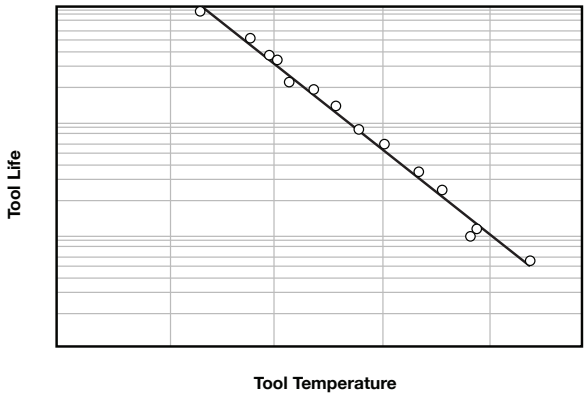

Figure 6: Typical tool life vs. temperature

As long as the tool is within the temperature range it has been designed to operate within, has the appropriate geometry, and is used on an appropriate material, the tool will continue to perform well.

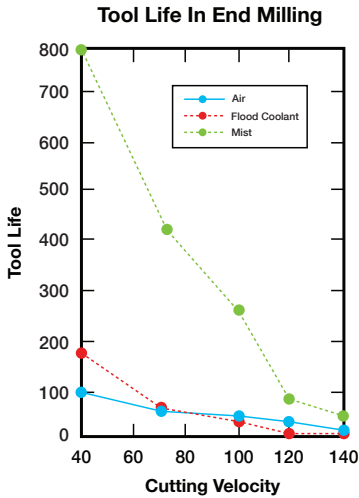

Figure 7: Tool life

can be dramatically different. Notice the tool life results shown below for MQL versus coolants in the milling of titanium. Flood coolant does not equal long tool life!

Traditionally cutting fluids fulfill three functions in machining. They

- (1) Remove heat,
- (2) Lubricate the cutting interface, and,
- (3) Remove chips

A flood coolant's primary focus is to remove heat. Large amounts of fluid are poured over the cutting interface. Some fluid gets into the cutting interface and does a limited amount of lubrication. Additives can help with the lubricity, but overall it is poor. It is a brute force approach; relatively process independent, and very messy.

MQL focuses on heat management and the elimination of frictional heat. Some heat is removed by the vaporization of the fluid in the cut. More is removed through convective transfer as air is blown across the cut in the delivery of the fluid. While these are of measurable benefit when compared to dry cutting, the actual heat removal is generally about half of that removed by a flood coolant.⁶ However an MQL fluid is specifically designed to be highly lubricious and work in the temperature ranges used in cutting. You can visualize the different emphasis as:

Flood Coolant	HEAT REMOVAL	Lubrication	Chip Removal
MQL	Heat Removal	LUBRICATION	Chip Removal

This emphasis on lubrication means different things for different processes. In drilling, the bulk of the heat is transferred into the tool from frictional contact rather than the shearing of the metal.⁷ It is easy to see why, in drilling, MQL's focus on removing the frictional heat can be so effective. In operations where the chips are in contact with the tool for a shorter time (milling, for example) the percentage of heat from friction is less. However, in milling, the cutting edge of tool is not continuously engaged in the cut. Since it is moving in and out of the cut, the opportunity for thermal shock is magnified. In processes with high speeds and feeds or short dwell times, MQL is often the best choice.

Heat can have some beneficial aspects. The work piece material generally gets easier to cut as it gets warmer. As long as the part is not changing dimensionally and the tool is not getting outside of its designed work zone, the heat can be helpful.⁶ Multiple studies on MQL have also found that different chemical reactions can occur in a cut when sufficient heat is present.

One study found that the synthetic esters used in many of the higher quality MQL oils react to form a protective layer on the tool's cutting edge. This barrier means "...the strength and wear resistance of a cutting tool can be retained which leads to a significant improvement of tool life." The authors go on to say that "there exists an optimal cutting speed at which a stable protective oxide layer can be formed. When cutting speed is lower than this speed, there is less oxide layer and the improvement of tool life is less apparent. As the cutting speed is far beyond the optimal value, the protective layer is absent and the thermal cracks are apt to occur at the cutting edge due to large fluctuation of temperature."⁸

The material cut can also be reactive. For example, it has been found that in Titanium, when cut with carbide tools, TiC forms. This acts as a solid lubricant that, like the ester barrier above, protects the tool. In dry cutting, the temperature gets too hot and this barrier burns off. It will form in flood cooling, but the thermal stresses cause the tool to break catastrophically. In MQL, the layer forms and the tool sees significantly longer life. This effect is, in part, what explains the tool life graph shown in Figure 7.⁹

Part of heat management is considering how heat will affect the work piece. In prolonged operations, thermal expansion may affect the tolerances and dimensions you need to set during the cut. It may dictate in what order operations are performed to minimize the effects of part expansion. By properly optimizing for MQL, some shops have been able to shorten the cycle time enough that the heating did not occur. For example, one manufacturer found by moving to MQL and making the corresponding adjustments in tools and speeds they were able to reduce the cycle for turning threads on a nut by around 40%.¹⁰ Another was able to change tool dimensions to account for the thermal change.¹⁰

So heat, when managed, can work in your favor. How much more heat is generated in MQL? Of course it depends significantly on the cutting parameters and the materials, but to give a general idea, the graph below in Figure 8 shows the temperature increases after milling 340 meters (13,385 in) in P20 steel with different lubrication types. The observant reader may notice that there was less heat with less MQL oil. In MQL, less is often better!

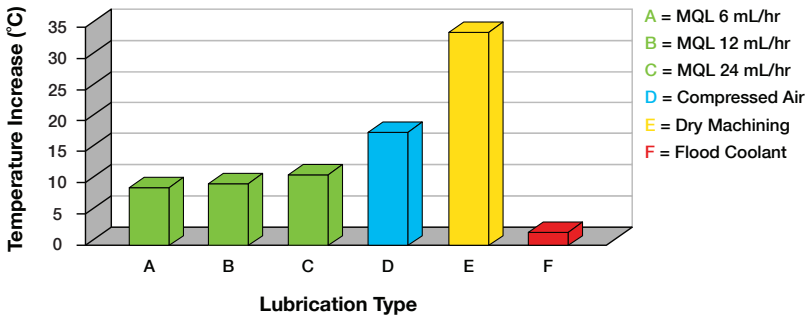

Figure 8: Temperature increase for different lubrication techniques

Less is more

As Figure 8 indicates, too much lubricant, especially oil-based lubricants, may cause unnecessary heat generation and tool wear. Field experience has shown that using too much oil reduces tool life and increases heat. Although the exact mechanisms are not clear, it appears that after a certain amount of lubricant has been delivered, there is no additional lubricity added by using more oil. The excess oil is not consumed and instead acts to retain heat. It may, in fact, leave enough residue on the chips to act as an adhesive layer. This adhesive layer increases the tendency of chips to clump together and increases the friction associated with their removal.

More is better

Experience has shown that materials can often be machined with higher speeds and feeds with MQL than with flood cooling.⁵ This has been seen in the high speed machining of most materials, drilling in structural steel, and several other applications. Sometimes, the increased load creates more favorable conditions for the tool. The graph in Figure 9 shows how, at a set fluid output, increasing the cutting speed can decrease the temperature.

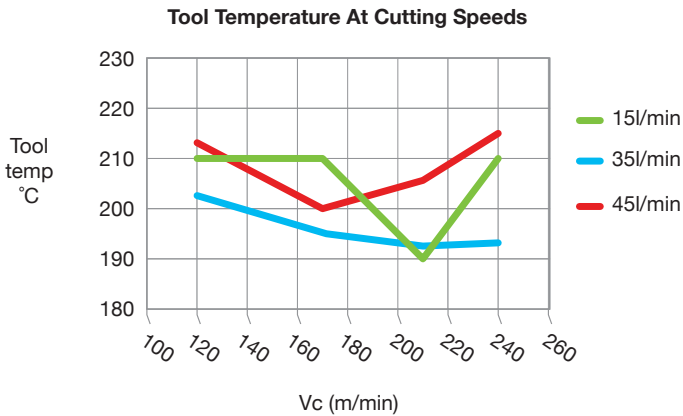

Figure 9: Temperature change at various cutting speeds

In some cases, when speeds are increased, the tool gets cooler because of the time it takes for the heat energy to transfer to the tool compared to the time in cut.⁷ This is seen more in high-speed machining.

Temperature at the cut, at moderate cutting speeds, is affected more by speed than feed so, if the tool and cut geometry allow, adjusting the speed will have the most impact on the cutting temperature. This in turn will reduce the temperature of the chip and in the secondary shear zone. Just as with water-based cutting fluids, a good indication that the speed should be increased is the presence of a built-up-edge on the cutting tool.

Faster feeds may also help when transitioning into MQL because increased feeds generally form larger chips which, in turn, carry more heat away from the cut. The heat generated at the primary shear line is dispersed on both sides of the line, but the chip is also deforming and ultimately tears off. This extra work on the chip side results in more heat in the chip; from a heat perspective, it is best to keep that the chip as large as possible and then move it away from the tool and work piece as quickly as possible.⁶

The sweet spot

These effects help explain the “sweet spot” often seen when optimizing for MQL. When in the zone - where the heat at the tool cutting edge is within the design parameters for the tool and any positive tribological effects are achieved - tool life is optimized. When outside of these parameters, it is not. The good news is that this zone is often fairly large.

MQL equipment

Moving to MQL is no different than adopting any other process: having the right tools for the job makes the difference between an easy transition and a failure. There are four main parts to the MQL ecosystem. The first is the applicator which determines how much air and fluid are dispensed. The next is the output; the hoses, chambers and nozzles or exit holes where the lubricant is released into the atmosphere. The tooling comes third. This includes the tool and tool holders. The final component is the machine. Where applicable, any machine-based programming that drives the MQL unit is included here.

Modern production environments can be demanding. The level of sophistication of the MQL system will often be determined by the complexity of the application. Simple open machines can use a simple bolt-on type system. Machining centers running complex parts and operations may need an MQL system that has integrated control and monitoring. More demanding MQL implementations may also require the assistance and cooperation of the machine and tool manufacturers to achieve the best results. This section should help you in understanding the options and differences so you can make an informed decision about what you need to best meet your specific needs.

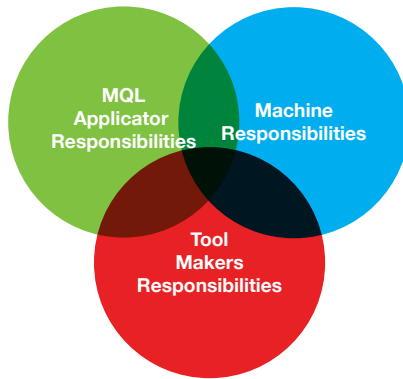

Figure 10: MQL system responsibilities

The applicator

In all MQL implementations, reliably getting the precise amount of air and lubricant to the work piece is critical to success. This is true in converting existing machines or specifying a new one.

An MQL system atomizes a lubricant into an airflow. This can be done at the applicator itself or just before the spray is delivered by the output. The first type, where the mixing is done at the applicator, is typically called a single-channel system.

This is because the combined mixture goes down a single hose or channel. When the lubricant and the air are carried separately it is a dual-channel system.

In almost all cases, the dual-channel approach is preferred. By waiting to mix the parts until they are needed, you get the most uniform droplet size and spray pattern. You also avoid oil collecting in hose bends or at changes in diameters in channels. Dual-channel delivery eliminates dripping and other side effects of the collected oil. Since the oil and air are mixed at the point of application, any changes that need to be made to the mixture happen immediately. The change does not have to work its way out to the end of a hose.

Although technically desirable, dual-channel systems are not always the most practical. When working with internally-fed systems on machines that were not designed for MQL, it may not be possible to get a tube or hose through the spindle for the separate channels. Since dual-channel systems tend to cost more, in some applications, the difference in price may not be worth the added performance.

What is the easiest way of determining if a system is dual or single-channel? Look at the output hose. Dual-channel hoses will have separate paths for the air and oil. This may be two tubes side by side or one tube inside of another (coaxial).



Figure 11: Coaxial and single-line hose

Some systems have tubing specifically designed for use on dual-channel MQL systems that allow for easy adjustment of the length as well as easy routing of a single tube.

Single-channel systems will have only one hose with no separate structure to carry the fluid. Simple application systems are designed to be adjusted manually. More sophisticated systems can be controlled directly from the machine control system via an M-code, ProfiBus, or other interface. This allows the required quantity of oil and air to be set by the program so it can be changed whenever there is a tool or process change. They can be monitored locally through alarms or remotely via MTConnect or OPC UA. This gives you the ability to tell when fluid needs to be replenished or if there is a blockage preventing effective fluid delivery.

Moving the fluid

There are three basic ways applicators move and mix the fluids through them. The simplest system is based on the venturi principle. Air is pushed through a venturi to siphon the fluid from the reservoir. This creates aerosol particles of approximately 0.5 μm to 5 μm . Venturi systems are single-channel only and have almost no moving parts. This makes them simple and reliable. However, external environmental conditions and variations in the incoming airflow directly affect the output; so, although reliable, they are not particularly precise. As is true in all single line systems, a venturi-based system is slow to react to changes in settings.

Systems that can support one or more channel are either pressure or pump-based. Pressure-based systems use a pressurized tank to force the lubricant through the system. The amount of lubricant delivered is controlled through a separate metering system. Higher quality pressure-based systems allow separate adjustment of the tank pressure,



Figure 12: Pressure-based system

the output airflow and the amount of oil injected into the airflow. These systems often allow several outputs to be connected and regulated from a single tank. Pressure-based systems produce a consistent output stream and have fewer moving parts than pump-based systems. However, even with a regulator, the pressure will vary some and most fluid's properties change with temperature. Like a venturi system, it is difficult to do precise adjustment of the amount of lubricant that is delivered. Furthermore, the number of outputs is limited by the pressure drop inherent in the design.



Figure 13: Pump-based system

Pump-based systems move the fluid using a small pneumatic or electric piston style pump. The pump allows precise control of the fluid output through adjustments of its stroke length and frequency. The positive displacement design ensures that exactly the same volume of lubricant is metered out with each stroke. It is the most precise and repeatable fluid delivery approach. Most pump-based systems have a modular design that allows multiple outputs, each with their own pump, to be combined in a single applicator. This makes for easy customization based on the needs of any particular machine. The disadvantages of the pump-based systems are that when set up incorrectly, the output stream can pulse as the pumps cycle and the pumps have moving parts that may wear over time.

The outputs

MQL depends on the lubricant getting to the interface of the cutting tool and the work piece. In some situations, an external nozzle is sufficient. In others, the cutting interface is not easily accessible and it is desirable to apply internal, or thru-the-tool lubrication.

This differentiation is important because the cost and difficulty of fully implementing an internal system is much higher than that of an external.

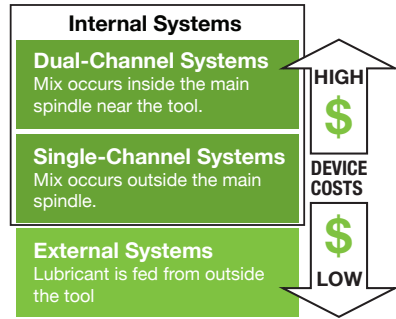

Figure 14: Internal vs. external system costs

With an external nozzle, the lubricant is applied to the outer surface of the tool. This system is good for open machines, intermittent cutting operations where the tool is not always buried in the work, and on machines that were not made with an internal coolant system.

On dual-channel systems, the external nozzle is designed to take the separate air and lubricant inputs and mix them at or near its tip. The lubricant is atomized and delivered to the tool in an aerosol form.

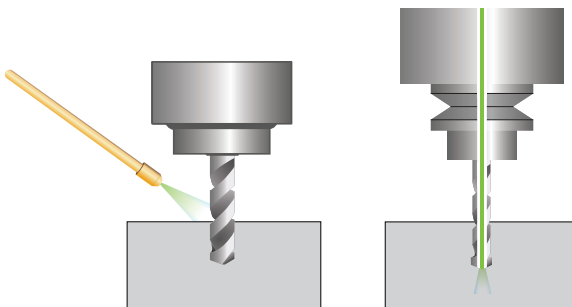

Figure 15: External vs. internal application

As with external systems, single-channel and dual-channel streams can be used with internally applied lubrication. In single-channel systems, the aerosol is generated in the applicator or just before entering the spindle. In dual-channel systems, the air and oil are fed separately through the spindle or rotary union and mixed when they exit the spindle or in the tool holder, to produce the aerosol directly in front of the tool.

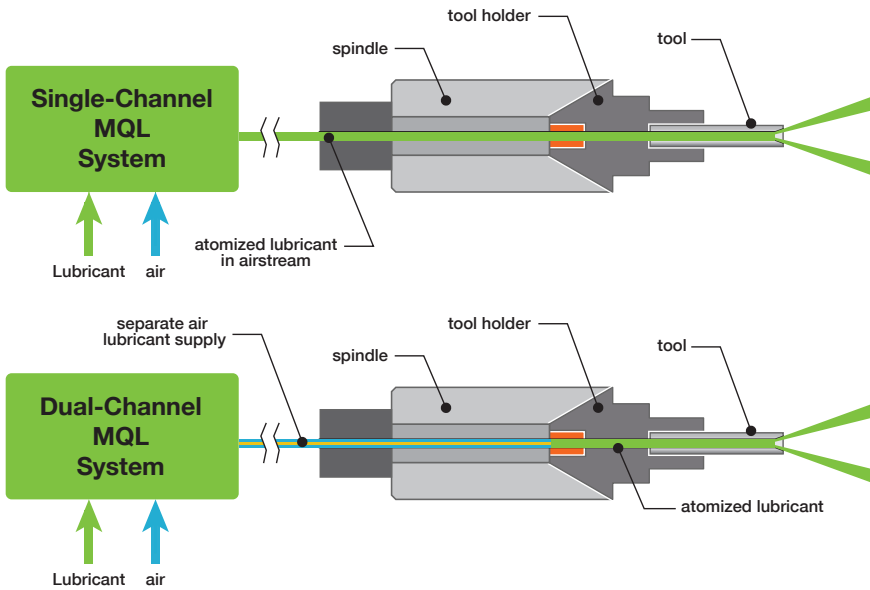

Figure 16: Single and dual-channel systems

Internal or external?

Low cost, simple installation, and the ability to deploy conventional tools are the key advantages of using external nozzles. However, there are several disadvantages. Nozzles have to be manually adjusted and positioned in ways that do not interfere with the tool or other moving parts in or around the machine. They may need to be adjusted to accommodate different lengths and sizes of tools. The output from a single nozzle cannot completely cover the circumference of a tool because of shadowing effects. There are

also losses due to the dispersion of the lubricant as it is delivered to the work piece. In cases where the cutting edge is embedded or hidden, such as when deep hole drilling, it is often wholly inadequate.

External Feed

Advantages	Disadvantages
<ul style="list-style-type: none"> • Simple to use 	<ul style="list-style-type: none"> • Limited adjustment options for the nozzles due to different tool lengths and diameters
<ul style="list-style-type: none"> • Low investment costs 	<ul style="list-style-type: none"> • Possible shadowing effects of the spray when machining
<ul style="list-style-type: none"> • Little work required to retrofit conventional machine tools 	<ul style="list-style-type: none"> • Dispersion of the aerosol outside of cutting interface
<ul style="list-style-type: none"> • Rapid response to changes in settings 	
<ul style="list-style-type: none"> • No special tools required 	

In spite of these imperfections, a great many machines and most operations can work successfully with external spray. Some of these applications include sawing, milling, broaching, shaping, drilling, and threading processes.

With internal feed, the lubricant is transported through the machine spindle, tool holder and tool to the machining point. This system is used primarily in machining centers designed for internal coolant and in high-speed machining. Using internal feed enables the aerosol to be applied directly, consistently and precisely to the cut. The lubricant is available during the entire processing sequence making it possible to drill very deep holes and use very high cutting speeds.

Internal Feed

Advantages	Disadvantages
<ul style="list-style-type: none">• Lubrication at the cutting point for each tool, even for inaccessible points	<ul style="list-style-type: none">• Special tools required
<ul style="list-style-type: none">• No shadowing or spray losses	<ul style="list-style-type: none">• Higher investment costs
<ul style="list-style-type: none">• Rapid response to changes in settings	<ul style="list-style-type: none">• Machine must be capable
<ul style="list-style-type: none">• Contains dispersion of aerosol	

On both internal and external delivery, a dual-channel system will usually give the best results. The channels should be maintained as far as possible; to the nozzle tip or if practical, almost up to the start of the tool. This allows very fast response times to changes in output, down to about 0.1 seconds. With this short delay, no time delays need to be added to cutting programs to make lubrication changes.

In machines designed for MQL, the separate channels are brought to the spindle and carried on through the spindle. Once in the spindle, the lubricant may be carried to the tool holder through a delivery tube. The air flows through a chamber in the spindle that surrounds the fluid delivery tube. In some specialized tool holders, the aerosol is mixed in a special chamber located just before the tool. In non-MQL-specific setups it is mixed somewhere near the end of the spindle itself. The aerosol is then delivered through the tool.

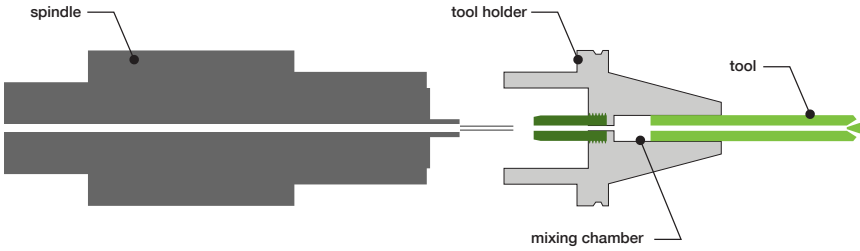

Figure 17: Dual-channel system components

The delivery tube eliminates the centrifugal effects caused by the rotating spindle and the separation of the oil out of the aerosol that happens when it hits the sides of the spindle. This approach allows much higher spindle RPMs while still maintaining the precision of the MQL output. It also keeps the inside of the spindle clean since the oil does not come into contact with it. It is important to ensure that the rotary union used is able to run with MQL. Many unions are designed to be used with flood coolants and use the coolant as a lubricant. When running in dual-channel mode, the union is essentially running dry and if it isn't designed for this, it may experience premature wear.

The description above is the best case scenario; it is how things work when the machine, tool holder, and tool are all designed for MQL. Unfortunately, putting all this in place isn't always easy. So, although desirable, practical considerations may make achieving this neither feasible nor cost effective. It is, however, always possible to run the dual-channel line to the spindle.

On machines that are not designed for internally-fed coolant, a coolant inducer would have to be used to get the aerosol down to the tool. At this time, there are no known dual-channel MQL coolant inducers and from the inducer onward it would be a single-channel.

Even if the machine was designed for internal coolant, it does not mean it will work seamlessly with dual-channel MQL. As mentioned before, some spindles have a rotary union that requires lubrication so the mixture must be done at the union to allow it to be lubricated. Some machines do not have room in the fluid channel for a separate oil line so, again, the aerosol needs to be mixed before the channel. Some have room for a partial fluid channel but not all the way to the tool holder. In these cases a shorter channel may be used. Some spindles have sharp angles inside that make running a separate line impossible.

Single-channel MQL can almost always be made to work even though it is not always as simple as one would wish. Some machines have chambers with sharp edges and cavities where fluid can collect and cause drips. Others have large changes in the cross-sectional area of the chamber that lead to air velocity changes which slow down the response time of the lubrication system.

As you can see, if planning on using internal MQL, it is a very good idea to talk to the machine manufacturer and the maker of the MQL applicator to ensure all the pieces will work as desired and provide the needed accuracy and control.

A short summary of the difference of the two internally-fed options is below.

Single-channel System	Dual-channel System
<ul style="list-style-type: none"> • Can switch between flood and MQL 	<ul style="list-style-type: none"> • Good response for switching between tools and cuts in machining centers
<ul style="list-style-type: none"> • Simple routing of aerosol stream to multiple spindles 	<ul style="list-style-type: none"> • Supplying multiple spindles from one unit more complicated
<ul style="list-style-type: none"> • May lubricate rotary unions and other internal parts 	<ul style="list-style-type: none"> • Requires a rotary union that can run dry
<ul style="list-style-type: none"> • Standard tool holder for internal fluid feed possible 	<ul style="list-style-type: none"> • Current MQL specific tool holders are only HSK (Hollow taper shank) style.
<ul style="list-style-type: none"> • Feed through complicated channels usually possible 	<ul style="list-style-type: none"> • Difficult to route through complicated channels
<ul style="list-style-type: none"> • Effective lubricant delivered effected by RPM 	<ul style="list-style-type: none"> • Lubricant delivered independent of RPM
<ul style="list-style-type: none"> • Reaction time to change lubricant and air relatively slow 	<ul style="list-style-type: none"> • Fast reaction time to changes in lubricant and air flow
<ul style="list-style-type: none"> • More air pressure needed (> 4 bar or 60 psi) 	

The lubricant

Minimum quantity lubrication is a total-loss lubrication method rather than the circulated lubrication method used with emulsions. This means only new, clean lubricant is used. Biocides, fungicides and other additives are eliminated. A good MQL fluid has very high lubricity and thermal ratings to withstand the high thermal and mechanical loads present. There are generally two types of fluids used: synthetic ester oils and fatty alcohols formulated for the proper range of vaporizations and flash points.

Types of MQL fluids

Synthetic esters are preferable for machining processes where the lubricating effect is of prime importance. This is the case for most materials and operations. These lubricants are designed for low viscosity while maintaining a high boiling and flash point.

This gives better results under load and generates fewer vapors than conventional mineral oils. In addition, ester oils have very good biodegradability and very low toxicity. Since such a small amount of the oil is applied, the parts are still considered dry (i.e. less than 2% of lubricant is present on the chip). However, there will likely still be a very small amount of oil on the part right around the cut. This minute amount of oil can help with corrosion resistance and item separation, but may cause issues in some secondary operations.

Fatty alcohols offer less lubricity but, because of their lower flash point, offer more cooling. They are useful when a little extra cooling is needed more than lubricity. This is often the case on materials that have some natural lubricity. If no sweet spot can be found using the synthetic ester and a built-up edge is being formed on the tool, the fatty alcohol may offer enough additional cooling to help. Fatty alcohols have very good biodegradability, and are toxicologically and environmentally harmless. Fatty alcohols also tend to be consumed more fully in the process than do the synthetic esters so the parts come out with little to no residue on them. This may be important when secondary operations will be performed on the parts.

Wetting:

The better the wetting properties, the better the lubricant will work. A fluid that spreads itself on the cutting surfaces is better at getting down into the interfaces between the tool and the work piece.

The wetting needs to occur on both the tool and the work piece, so both materials need to be considered. A quick way of comparing how fluids will wet on a material is by taking a drop of liquid and putting

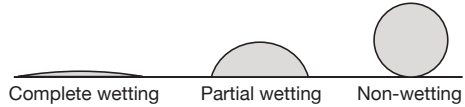

Figure 18: Wetting

it on the material and seeing how well it spreads out. The more it spreads, the better it is wetting. Extreme Pressure additives, such as sulfur, can greatly change the wetting property on different materials, so it is best to test with the specific fluid that will be used.³

Photos courtesy of Wayne NP Hung



0.25 μL Water



0.25 μL 2210 EP

Figure 19: Visual example of wetting on stainless steel

Viscosity

Generally, better wetting properties mean lower fluid viscosities. Unfortunately, lower fluid viscosities increase the tendency for the fluid to generate a mist. The following chart shows measured emission levels at the cutting interface and at the extraction point for different viscosities on a drill. To help keep the emissions to a minimum, it is suggested that products with higher viscosities and flash points (> 150°C or 300°F) are used.

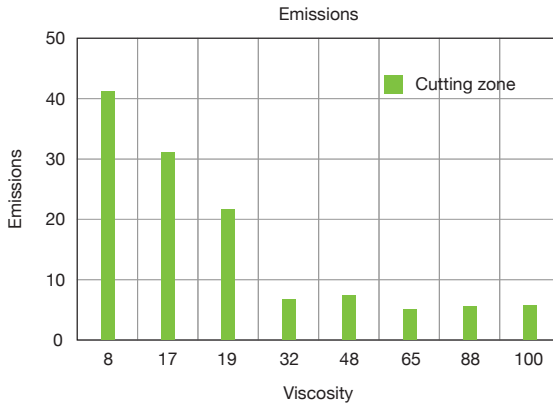

Figure 20: Emissions at cutting area based on viscosity

In selecting an MQL fluid, one needs to balance its wetting properties with its emissions. This balance point will be different for open versus closed machines and on closed machines with emission control devices versus those without. However, a high quality MQL-specific fluid will work well with a minimal amount of misting.

Tools and tool holders

Not surprisingly, the tool is an important piece of the total MQL ecosystem. Tools that were selected based on the conditions found in wet machining may not be best for use with MQL. MQL is based on reduced heat development and rapid heat dissipation via the chips instead of rapid cooling by fluid. MQL compatible tools should be designed to work at higher heat levels and the geometry of the tool should be optimized to transfer the chips away from the tool as quickly as possible. This is in contrast to tools designed for wet cutting that may be optimized for maintaining an edge through repeated thermal cycling. For example, High Performance Cutting (HPC) drills are characterized by high-performance materials, MQL-compatible coatings and geometries that assist with chip removal.

Some tool coatings are more MQL friendly. Hard material layers help to thermally insulate the tool and polished tool surfaces help minimize the friction. Geometry, such as rake and clearance angles, should be designed to create, break, and move chips away from the tool. For example, in drilling, the optimal chip is short, but with at least one spiral. Tool manufacturers who offer MQL-compatible tools can give specific guidelines in selecting the right tool for the required process, and give material-specific and tool-specific cutting parameters (e.g. feed, cutting speed).

One manufacturer of nuts, using a two-spindle horizontal lathe, tried converting to MQL by simply switching from a flood to an MQL applicator. Unfortunately this simple switch did not put this operation in the sweet spot. The resulting heat in the cut kept them from meeting the required tolerances on the threads. However by selecting a more appropriate tool for the new process they cut their cycle time down by 35%. This shortened time kept the part cool enough that the tolerances could be maintained and, as would be expected with an increase like that, gave them a substantial boost to their production capacity.¹⁰

In internally-fed tools, there are several elements in the tooling that should be considered. The interface between the lubricant feed and tool/tool holder should be sealed in order to prevent any lubricant from escaping into the clamping area of the chuck or the interior of the machine. The lubricant holes should be designed to uniformly coat the cutting edge and avoid any blind spots. An elliptical channel that increases the cross section area is often desirable.



Figure 21: Thru-the-tool exit holes

Current tool holders designed for MQL are HSK style and have a mixing chamber built into them. Non MQL holders often have sharp angles on the internal edges. Just as in the spindle, the centrifugal force pushes the aerosol to the sides which cause the oil and air to separate and can result in dripping and unwanted oil build up. Also, the large change in diameter from the spindle channel to the cavity in the tool holder can cause airflow velocity changes that make it more difficult to maintain and change the output at the tool.

The machine

Depending on the machine requirements and how far you want to take it, optimizing for MQL can range from doing nothing to making extensive modifications. With open machines using external nozzles or machines using single-channel MQL, there is usually little to do outside of attaching and connecting the applicator, routing the hoses, and positioning the nozzles. If the machine is to use an internal dual-channel system, the changes to the spindle can be more involved.

Machining centers are where the most can be done to optimize for MQL. An MQL optimized machining center will generally have the following characteristics:

- The sides of the work area are at least at a 35° angle allowing gravity to move chips down to the bottom.
- There are no obstructions, edges or horizontal surfaces where chips and dust can accumulate. This includes having flush heads on any fasteners.
- The sides are smooth, unpainted surfaces (e.g. stainless steel) so the chips can easily slide off them.
- A large opening at the bottom to collect the chips, and/or a conveyor to remove them.
- An extraction system suitable for removing emissions and any metal dust generated.

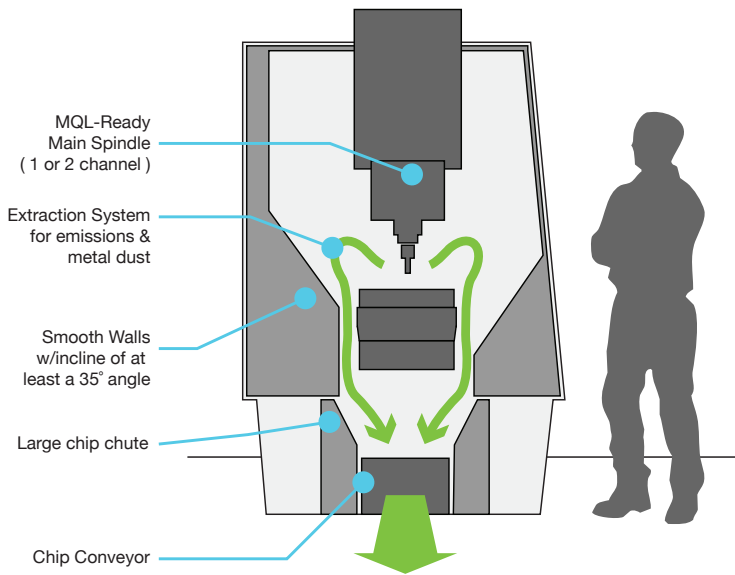

Figure 22: Elements of an MQL-specific machining center

Emission extraction systems

The efficient removal of the emissions created by the machining is very beneficial in MQL. Continuous extraction of any lubricant mist and metal dust helps to:

- Promote the well-being of employees
- Improve machine cleanliness
- Increase process reliability
- Decrease downtime
- Meet OSHA and other regulatory standards

Unlike wet machining, MQL extraction systems may have to remove metal dust as well as aerosols. The extraction system should be designed to handle this dust to avoid premature failure. This usually takes the form of a screen in front of the inlet of the extraction system. The flow rate in the extraction pipe work should also be high enough to prevent dust accumulations from forming inside. As a rule of thumb, the flow rate should be greater than 20 m/s (65 fps).

The pressure inside the machine should be slightly less than the outside pressure to create an inward airflow through any openings so no emissions escape when the doors are opened or through other openings.

However, if the flow rate is too high at the extraction point, the chip protection screen in front of the extraction inlet can clog. If needed, dust can be separated from large chips by installing a deflector plate and droplet separator.⁵

Unlike conventional extraction systems in wet machining where air is extracted through the upper part of the machine, MQL emission extraction is often more effective closer to the work. Some machine manufacturers offer extraction openings that are incorporated into the spindle head allowing extraction to take place very near to the cutting zone. The emission extraction systems may also be done near or at the chip removal area. This has the advantage of bringing any dust and chips down to the removal area.

Air curtains or blow-offs along the inner wall of the machine may also be used to keep the sides clean and improve chip removal. This prevents caking and crusting of metal dust on surfaces.

How to implement MQL

Training

Training is first in this list because it is one of the more important, and often most overlooked elements to successfully implementing MQL. Most machinists are familiar with flood coolant and how it works but many of the habits formed when working with wet machining are not helpful when using MQL. In fact, they can be harmful.

The MQL lubricant spray, even when externally applied, is often nearly invisible. Adjusting the output to the point where you can see it does not help. Instead, it has the potential for filling the work area with mist, it wastes fluid, and it likely takes the process out of the sweet spot. Blasting too much fluid with too much air pressure is probably the most common mistake when first implementing MQL. The cycle perpetuates itself because when the initial blast doesn't work and the knobs get turned even higher. More is not necessarily better! Training on MQL for all operators on all shifts is important to keep the system working and running smoothly.

Basic MQL training should include how to properly set and adjust the system, a review of the principles behind the technology and an explanation of the health and safety benefits of a properly adjusted system to the machine operators. This training helps ensure the overall success of MQL and assists in a seamless roll out of the new technology.

Considerations when setting up the applicator

The applicators themselves are generally easy to install. They either bolt directly to the machine or are mounted with magnets. Most will have an electric solenoid valve to control the on/off operation. This valve needs to be wired into the appropriate circuit on the machine so it will turn the applicator on at the appropriate time. This may be into the trigger on a saw or into the M-codes relays on a more complex machine. An air supply will need to be connected to the unit (typically requiring 480 to 690 kPa or 70-100 psi) and any tank or fluid reservoir filled with an MQL fluid. Pumps may need to be primed and hoses filled so that the fluid is ready to be dispensed. These are straightforward tasks and are usually quickly completed.

Care should be taken when running the fluid lines to ensure that they will not be hit by any moving parts and that hot chips will not be landing on them. Many systems use polyurethane hoses and the hot chips can burn holes in them. As mentioned earlier, if you are using an evacuation system on a machining center, the airflow around the hose entry points should be minimized or eliminated to maintain the desired flow pattern in the machine.

More advanced application units have monitoring systems that will also need to be connected. These may include low-level sensors that will sound an alarm or shut off the machine when the fluid level hits a predetermined point and flow sensors to ensure fluid is being delivered. Since the output of the system is usually invisible to the operator, he or she may not notice when the fluid is gone and may unknowingly begin cutting dry. A fluid flow sensor can help avoid potentially costly mistakes.

More challenging is establishing the proper setting for the amount of air and fluid to be applied. Like all machining settings, there is a definite element of “art” to the “science.” MQL is no different than wet machining in that proper settings are dependent on the tool type, tool materials and coatings, tool size, tool geometries, tool wear, cutting geometries, cutting speeds, cutting feeds, work piece material properties, chip formation dynamics, machine rigidity, and so on. Since there is no way to precisely account for all of these, the following sections of this booklet will give general rules of thumb. You will need to do some experimenting and tweaking to find the sweet spot for your particular job.

The goal of MQL is simple: apply just enough fluid to fully lubricate the operation with the least amount of airflow needed to carry the droplets to the tool. This keeps the cut and tool well lubricated while minimizing any excess aerosol that could be generated. Some factors to consider:

- 👍 There are two places that need to be lubricated: The tool/work piece interface and where the chips come in contact with the tool. On a tool with a large chip contact surface, like a drill, more area needs to be covered than on a tool with relatively little chip contact.
- 👍 Airflow/droplet speed. Too slow and the fluid does not make it to the tool; too fast and droplets can bounce off the intended target or are blown throughout the shop.
- 👍 The longer the distance that the nozzle needs to spray, the more airflow is needed to carry aerosol and the higher the likelihood of an unwanted mist being generated. In closed machines, an extraction system can help with this. In open systems, putting the nozzle closer to the cut helps. This can often be done by creating a special nozzle that places the spray just where it needs to be.
- 👍 Different fluids form different droplet sizes, which will weigh different amounts and therefore require different airflows to carry them. You will need to determine the optimal position and flow on a per-fluid basis.
- 👍 Tool RPMs affect how long the surface of the tool is facing the nozzle, how much force is trying to throw off the fluid, and the strength of the air barrier around the tool. After a certain point, the fluid will not get-to or stick-well-to the tool.

MQL works far better than water-based emulsions in penetrating this barrier and is one of the reasons it is usually the best option in high-speed machining.

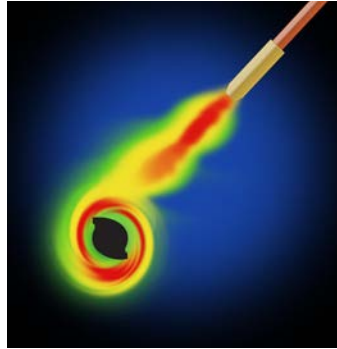

Figure 23: Airflow around high speed tool

Rules of thumb for external nozzles

- 👍 Unless you are working with very small chips, as in micro-cutting, trying to blow the chips away with air from the fluid delivery spray will only create a fog and use more fluid than is necessary. Use a separate chip removal approach, such as an air blow-off or a vacuum, to remove chips if needed.
- 👍 If practical, moving the nozzle closer to the work will allow lower air volumes to be used.
- 👍 On pump-based systems, ensure the system is adjusted so that any pulsing from the output is eliminated. A good way to do this is move a piece of cardboard in front of the nozzle as it is spraying and check that the output is consistent in size; There should be no “spitting” of larger droplets. See the Coolubricator system adjustment video at www.unist.com for an example of how to make these adjustments on a manually-controlled system.

- 👍 When face or end milling, the best nozzle location is 135 degrees from the cut in the direction of rotation. 45 degrees does not work as well because chips and turbulence block the fluid from getting to the tool. 135 degrees lubricates the tool before use and minimizes both tool wear and oil use.¹¹
- 👍 There is also a dead zone in fluid coverage when a tool that is perpendicular to the cut. This is because the tool itself blocks the fluid and is generally 180 degrees from the nozzle. Cutting should not be done in this dead zone. If working with a machine that has a fixed position nozzle and may cut in multiple directions, such as a mill, more than one nozzle is recommended to eliminate the dead zone.
- 👍 On the vertical plane, the nozzle should be placed so all the tools to be used are adequately covered by the output spray. For longer tools this may mean the angle from the vertical is less than the 60-70 degrees shown.

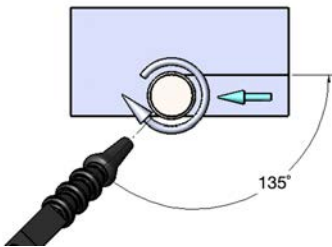

Figure 24: Optimum position of external nozzle for end milling

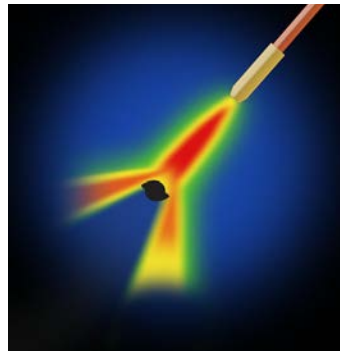

Figure 25: Dead zone with single nozzle output

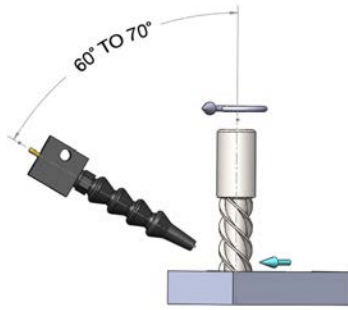

Figure 26: Vertical position of external nozzle

- 👍 In peripheral milling, or when the tool is parallel to the work piece, the dead zone starts closer to 100 degrees from the nozzle. The nozzle should be placed close to horizontal spraying the tool before it enters the cut to fluid delivery. It is placed before entering the cut, not on the back side, so no chips or turbulence interrupts the aerosol flow.³

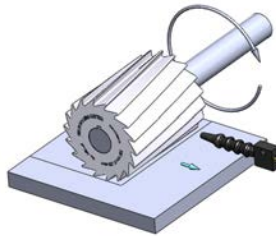

Figure 27: Optimum position of external nozzle for peripheral milling

- 👍 The nozzle should be placed so that it is spraying the tool/work piece interface. In some cases this may mean the nozzle is attached to the bed or the work piece holder. In other cases it can be connected to the spindle arm.

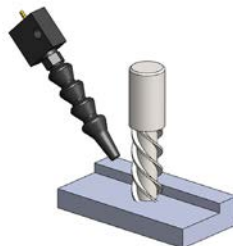

Figure 28: Nozzle positioning

- 👍 Traditional needle-style nozzles are made in a few different styles. They may be made of plastic (e.g. Loc-line®), softer, more flexible metal, or harder metal.

Select the type of nozzle appropriate for machine and work. If the nozzle will need to be adjusted, often a plastic Loc-line® style may be appropriate. But this style's strength, that it is easy to move, is also its weakness. The nozzle can just as easily be moved by chips. This design can also leak air around the "links" so maintaining an exact air setting is more difficult. More solid designs, such as copper or stainless steel tubes, are generally more practical because they are less prone to move with contact or vibration.



Figure 29: General purpose nozzle options

- 👍 Specialty nozzles, such as those for saws, are also available and are more effective and less intrusive. For example, the nozzle shown in Figure 30 packages three outputs that coat the sides of the blade and the gullet of the teeth in a single compact unit. On band saws with guide lube points, an MQL output can also be attached to this to ensure the blade has adequate lube throughout its path.

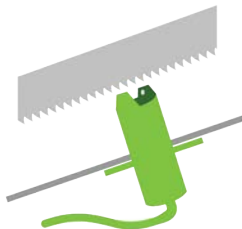

Figure 30: Saw blade nozzle



A 90% blade life increase was gained using MQL on this solid by using a specialized saw nozzle

- 👍 Turning operations can be a challenge for MQL. Specifically, it can be difficult to place the nozzle. Because turning is a continuous operation where the cutting edge is buried in the cut, getting the fluid to the cutting interface can be difficult. However, with carefully-placed, and perhaps specially-designed nozzles, MQL can be quite effective. For a detailed case study on fitting a Mazak Turning center, see the white paper “MQL in Turning Operations” in the “White Papers” section under “Info & Support” at www.unist.com.

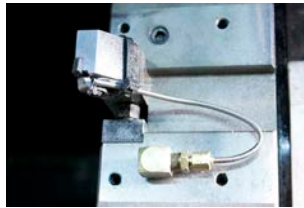





Figure 31: Nozzle on a turning center

Rules of thumb for MQL fluids



- 👍 How much fluid to use depends on the size of the tool, the contact area between the chip and tool, and the time in the cut. As a general rule of thumb, fluid use of 5 to 80 mL (0.2 – 2.5 oz.) per hour of cutting time on tools less than 40 mm (1.6 in) in diameter seems to keep chips dry and give good results. Always use the least amount needed to achieve maximum tool life. Remember that oftentimes, less is more.
- 👍 If chips are sticking to the tool, you are putting on too much oil. It is acting as a chip adhesive more than a lubricant.
- 👍 If the chips or the work piece material is welding to the material, or you are getting a built-up-edge, you need to adjust the fluid, try a different speed setting, or change the tool. There is too much heat.

- 👍 The fluid output should be virtually invisible. If you see a mist spraying from an external nozzle, you will likely see fogging in the plant.
- 👍 Make sure the fluid will wet your cutting tool and work piece materials by doing a droplet spread test. Apply droplet to a clean tool or work piece surface. The surface must be clean. Use degreaser or alcohol to clean and wait till the surface is dried. If it does not wet, then you will not see the lubricating benefits of the fluid – no matter how much of it you put on. You only need to confirm this once when using a new tool coating or work piece material.
- 👍 Experience shows that the best results with lubricants (ester or fatty alcohol) are achieved at a viscosity range of 10 to 50 mm²/s (0.016 to 0.77 in²/s) and in some cases up to 100 mm²/s (0.155 in²/s) at 40 °C (104 °F). Higher viscosity limits should be discussed with the MQL system manufacturer to ensure they will spray correctly. Lower viscosity fluids tend to mist.
- 👍 It should be determined if the thin, post-machining residual film left by MQL offers satisfactory corrosion protection or whether additional corrosion protection is necessary.
- 👍 The choice between an ester oil or a fatty alcohol is dependent on the process and materials. One study found that when end milling hardened steel at lower speeds, the ester oil gave the best results. At higher speeds, a built-up-edge was formed and the alcohol gave better results. The choice should be made based on the material of the work-piece, the material and coating of the cutting tool, and the speeds/feeds of the cutting operation.

Some fluids that are not suitable for MQL

-  Water-miscible metalworking fluids. These do not offer the proper lubricity or flash point for use in MQL. Also any biocides in the fluid may get into the air and can be a safety issue.
-  Lubricants with additives containing organic chlorine or zinc should be avoided. They often react at the temperatures found in MQL machining and cause harmful byproducts.
-  Natural oils and greases. Natural Esters (rape seed oil, etc.) will lubricate but are prone to oxidation and in a relatively short time gum up the machine and everything else they come in contact with. **Note:** this does not apply to the synthetic esters derived from these oils, but those found in the unprocessed oils.
-  Mineral oil-based products with high aromatic compound content.

Material

-  Gray cast iron (e.g. GG 25- GGG 40) works very well with MQL since the graphite component in it acts as an additional lubricant. Further, measurements show that in both milling and drilling a significant reduction of the temperatures can be achieved with the increase of feed rate. The tool geometry has a very high influence on the heat generated.
-  When cutting cast iron or other materials that may form a dust consideration must be given to the dust removal in advance of implementing MQL. Flood coolants help keep down the dust as well as providing some lubrication. On an open system, a vacuum or other means of capturing the dust will likely need to be installed when moving to MQL.

- 👍 Non-ferrous metals (e.g. aluminum with up to 1% Si) and steel materials up to 800 MPa tensile strength (e.g. free-cutting steel, quenched and tempered steel CK 45) cut very well.
- 👍 Even traditionally difficult-to-cut materials can be machined with minimum quantity lubrication if the process is properly designed. With proper chip evacuation, sawing Inconel has proven to work well. In high speed and micromachining Titanium, MQL has been shown to work better than dry machining or machining with flood coolants. Specifics will change based on each job's particulars, but even with more exotic materials, MQL can yield substantial improvements.
- 👍 Milling in Ti-6Al-4V worked very well because the carbide tool-material combined with MQL causing the formation of a sustainable layer of Titanium Carbide (TiC) that acted as a friction-reducing agent with a solid lubrication effect and minimized the other wear mechanisms. With this, at the same cutting speed, the tool life achieved by using MQL was significantly longer than the tool life with the other lubrication methods.⁹
- 👎 Some metals have proven to be more difficult. For example, heavy cutting of copper can be problematic because the heat dissipation is insufficient. Problems may also occur when cutting magnesium due to the flammability of the chips and dust.
- 👎 Using Polycrystalline diamond (PCD) coating on tools when machining Aluminum, test results show that carbide tools provide better tribological behavior, that is less friction and less surface adhesion, than do PCD coated tools.¹⁵

- 👍 When using HSS tools on Aluminum, using MQL reduces the friction and surface adhesion to approximately one-quarter to one-fifth of that found when dry machining with the same tools. Unlike dry behavior, where at slower speeds high friction and adhesion were seen, with MQL the results with both TiCN coated and uncoated HSS tools was the same regardless of the cutting speed.¹⁵
- 👍 When using Carbide tools on Aluminum, MQL reduces the friction and surface adhesion to approximately one-third of that found when dry machining with the same tools. A TiCN coating does not seem to provide lower frictional results than uncoated carbides.¹⁵

Tools

In MQL, as in all cutting, the two largest causes of tool wear are mechanical and thermal. These are often related since high temperatures can cause more mechanical wear and mechanical issues can cause high temperatures. Proper tool selection can help minimize these issues and prolong tool life.

- 👍 Tools that are designed for dry cutting typically work well with MQL. Tools for flood coolant may be optimized to resist the thermal shock associated with that process where tools for dry machining are often designed to run at a higher temperature.
- 👍 For the machining of high-strength steels, the use of a multi-layer coating is recommended, especially those with a TiAlN base layer. This coating significantly increases the temperature range allowed. This coating has shown good results on titanium, aluminum and nickel alloys, stainless steels, alloy steels, and Co-Cr-Mo. A small layer thickness helps contribute to achieving stable process conditions.

One manufacturer, using a TiAlN coating on tempered steel was able to move from a speed of 150 m/min (492 ft/min) to 250 m/min (820 ft/min) while holding a roughness of 3 – 5.2 microns.¹⁰

Another manufacturer cutting internal threads on ball screws had a tool specially designed for their MQL cutting operation. They were cutting 34CrNiMo6 steel and by using finite-element analysis in their tool design and adding a TiAlN multi-layer coating created a tool that allowed cutting with MQL that cut their processing time from 12 hours to 3 hours per part.¹⁰





Still another manufacturer who drills holes into unalloyed structural steel (ST 52-3 1.0052) for spindles in vices and metal shears determined that by using a fine grain TiN coated carbide tool instead of HSS, they could use MQL and increase cutting speed by a factor of 5. They also selected a drill with a larger flute and side rake angle so the drilling process was efficient even at higher cutting speeds. The average surface roughness was around 8 to 10 microns, well below their 25 micron limit.¹⁰

 Tools for MQL may also be designed to break the chips and move them away from the tool more quickly. Chip size (e.g. in roughing vs. finishing) also may affect the need for coatings because of how much heat the chips can absorb. Tools that generate smaller chips tend to need a coated tool more than those that create large ones.

Although these tools may cost more, using the right tool will allow the machines to run as fast, or faster, while holding very tight tolerances and reaping the benefit of MQL surface finish improvements.¹²

Chips

Chip removal in MQL is different than in flood cooling. In some ways it is harder; there is no fluid to wash chips away from the cut. In other ways it is better because a system designed for MQL uses air, gravity, or other means to carry the chips away in a clean and green manner.

-  Fast and complete removal of chips and metal dust from the workspace is important. Hot chips in contact with the tool or the work piece will increase the heat at that point. Chip accumulation and residues in the work area (e.g. on the work pieces and machining equipment) should be avoided as much as possible.
-  Chip disposal can often be accomplished through work space design. When practical, using gravity to move the chips is a proven simple method. In enclosed machines the chips should fall on to steeply inclined metal siding into a collector or onto a conveyor. Projecting edges and horizontal surfaces should be avoided.
-  Position of the work piece can also help with chip removal. A suspended work piece works well on a vertical lathe. In machining centers, using a pivot axis may allow the work piece to be suspended and rotated so that the chips fall from it.
-  Another option for chip evacuation is an air blow-off. Compressed air can be used to blow the chips away from the work area. Pulsed air often works well for this and also minimizes air consumption. When using an air blow-off, consideration should be given to the emissions and metal dust that will also be blown. The use of an emission system can help alleviate any issues associated with this.

👍 When using air, it is recommended that a separate air blow-off nozzle be used and not the nozzle that delivers the MQL fluid. Except in cases where the chips are very small or very fine, such as in micromachining, the air volume needed to move the chips is much higher than that needed to deliver the fluid. Trying to use one nozzle for both tasks will likely end up doing neither very well.

What does moving to MQL mean in terms of overall effectiveness?

MQL can have positive impact on Overall Equipment Effectiveness (OEE) as well. One example of this is Ford Motor Company in its Van Dyke Transmission plant. They adopted MQL and saw many of the machining specific advantages that have already been discussed at length. But they also found secondary advantages significantly impact equipment effectiveness and overall operations efficiency. Ford estimates that the total cost of ownership with MQL, based on machine cost, downtime, maintenance, floor space, electricity usage, coolant management and related factors, decreased by 13%. Availability of the machine is increased because the electronics on the machines last longer and have fewer nuisance faults. This improved machine up time from 50-60% to 80-90%. CMMs could be placed on the shop floor near the machines and did not need enclosures. Their aluminum chips could go straight to the recycler without secondary cleaning operations being needed. The plant's floors could be made flatter since there was no need to engineer floor drainage systems, and assembly could be moved closer to the machining cells greatly reducing part travel throughout the facility.¹²

These highlight some of the advantages of implementing MQL that go beyond cutting and to the machine and the plant itself. Increasing machine up-time and reducing maintenance are great ways of improving OEE and your bottom line.

Conclusion

Hopefully the MQL handbook has given you a better idea of what MQL is and how to implement it. It is not always as simple as just plugging in a lubrication system, but it does offer significant advantages to the business, the employees, and the environment. It cleans up the plant, often improves tool life and surface finish, increases meantime between failures on machines with electronics, and dramatically reduces fluid related costs. If these are important to your operation, then perhaps this would be a good time to give MQL a try.

Appendix 1: Resources

Unist product information: <http://www.unist.com>

Unist videos: <http://youtube.com/user/UNISTInc>

Unist product literature: <http://www.unist.com/info-support/product-literature/>

Appendix 2: Examples of successful MQL settings and results

Material	Operation	Parameters	Results
Steel ASSAB 718 HH	Low Speed Milling	8.5 mL/hour (0.29 oz/hour) fluid flow rate Cutting speeds between 75-125 m/min (246-410 fpm)	Lower cutting forces, thermal stresses and burr formation than flood coolants. ¹³
NAK80 hardened steel	Milling	10 mL/h fluid flow rate Speeds between 150-250 m/min (492-820 fpm)	Better results than flood cooling, and the benefits increased as the speeds increased. ¹⁴
Ti-6Al-4V	Milling	10 mL/h (0.33 oz/hr) fluid flow rate Carbide insert	Significantly better tool life and lower cutting forces compared to flood coolants, especially when feed rates were larger than 0.08mm/tooth. ⁹
Micro MH2. HB200-220 D2. HB180-200 (475 mm solid)	Sawing on a Kasto Twin A4	Oil consumption 19.42 mL/hour (0.65 oz/hr) 12mm per minute (4.1 ipm)	26%-90% increase in blade life. ¹⁰
AlMgSi1	Milling	Roughing end mills VHM/ TiAlN, d = 8.0 mm (0.31 in) Finishing pockets mills - VHM/ TiAlN, d = 5.0 mm (0.196 in) Cutting parameters: Rough vc = 340 m/min (1115 fpm), fz = 20 μ edge processing mills - VHM / TiAlN, d = 3.0 mm (0.12 in) finishing vc = 250 m/min (820 fpm), fz = 15 μ; edging vc = 220 m/min (721 fpm), fz = 12 μ	Successful MQL milling of Aluminum Piston. ¹⁰

X 5 CrNi 18 10, material no. 1.4301	Sawing	Bi-metal saw blade 27 x 0.9; M2 uncoated., Standard tooth; Standard set, 5 - 8 tpi	Sawed face roughness of 27 microns was maintained, MQL successfully implemented
AlMgSi0.5, polyamide 6.6, PUR foam	Sawing	KSB Ø315x3.0x40, HSS, 240 teeth Cutting parameters $V_c = 2866$ mm/min (112 ipm); $v_f = 2274$ mm/min (90 ipm)	Met roughness goals of 10.3 to 14.0 microns on AL and 10.1 to 12.6 micron on foams. ¹⁰
Unalloyed structural steel (ST 52-3 1.0052)	Drilling	Speed 150 m/min (5905 ipm), TiN coated carbide tools	5X increase in speed rate, improved surface finish. ¹⁰
Steel (42CrMo4)	Drilling	$V_c = 250$ m/min (820 fpm) $f = 0.1$ mm (0.004 in)	$R_z \sim 3.0$ to 5.2 microns
Steel (16MnCr5)	Centering (Drilling)	Tool: D = 6.3 x 20 mm (0.25 x 0.79 in) N = 500/min Vf = 50 mm/min (1.97 ipm)	1200 centers
Steel (16MnCr5)	Drilling	Stepped drill D = 6.8 x 10 x 28.5 (0.26x0.30x 1.12 in) N = 2 800/min Vf = 504 mm/min (19.85 ipm)	2400 holes
Steel (16MnCr5)	Reaming	Tool D = 7 H8 N = 690/min Vf = 152 mm/min (6 ipm)	1200 operations
Steel (St38MnVS5)	Drilling	HSS-Drill, D = 14.5 mm (0.57 in) N = 330/min Vf = 52.8 mm/min (2.07 in)	500 holes

Steel (St38MnVS5)	Counter-sinking	HSS-countersink 90° N = 90/min Vf = 5.2 mm/min (0.20 in)	960 operations
Steel (St38MnVS5)	Threading	Tap M16 x 1.5 (0.62 x 0.059 in) N = 90/min Vf = 135 mm/min (5.31 ipm)	500 threads
Al Si 7 Mg	Sawing	Band Saw	> 2000 cuts
Al Si 7 Mg	Milling	Surface mill	Approx. 6000
Steel (CK 45)	Impact drilling	HSS-Drill, D = 14 mm (0.55 in) N = 200/min Vf = 40 mm/min	100 – 150 holes
Al Si 10 Mg	Milling	End mill N = 4 000/min Vf = 1200 mm/min (47.25 ipm)	Approx. 105000
Al Si 10 Mg	Milling	Surface mill	Approx. 3500
Al Si 10 Mg	Sawing		Approx. 4500
Al Si9 Cu3	Deep hole drilling		5000 holes

Sources

- ¹Standards committee tools and clamping devices (FWS) working committee. “DIN 69090-1 MQL Machining Technology-Part 1.” Terms and Definitions. (Article), DIN 69090-1:2011-12, (December 2011)
- ²DeVries WR, Murray SF. (1994) Tribology at the cutting edge: cutting and grinding fluids. In Masudi H, editor. Tribology symposium-1994. New York: American Society of Mechanical Engineers. pp. 23–33. ISBN 0 7918 1189 1.
- ³Oberg, Erik, Jones D., Franklin, Horton L., Holbrook, Ryffel H. Henry, Jones D. Franklin. Machinery’s Handbook 29th Edition Toolbox. Industrial Press, 2012
- ⁴Unfallversicherung, Deutsche G. “Minimum Quantity Lubrication for Machining Operations.” MQL for Machining Operations. (Article), BIG/GUV-I718E, (November 2010)
- ⁵PETER C. RAYNOR¹*, SEUNG WON KIM¹ and MRINAL BHATTACHARYA, Mist Generation from Metalworking Fluids Formulated Using Vegetable Oils, Ann. occup. Hyg., Vol. 49, No. 4, pp. 283–293, 2005 British Occupational Hygiene Society
- ⁶<http://www.cnccookbook.com>. Feeds and speeds tutorial for CNC. The feeds and speeds cookbook, 2011-2012
- ⁷Agapiou S., John, Stephenson A., David. Metal Cutting Theory and Practice. Boca Raton: CRC Press, Taylor and Francis Group, 2006
- ⁸Liao, Y.S., Lin, H.M., “Mechanism of Minimum Quantity Lubrication in High-speed Milling of Hardened Steel.” (Article), (November 2, 2006)
- ⁹Et al., J., Sun, “Effects of Coolant Supply Methods and Cutting Conditions on Tool Life in End Milling Titanium Alloy.” Machining Science and Technology: An International Journal. (Article), 10/3:355-370, (2006)
- ¹⁰Weinert, Klaus, Schmidt, Jürgen, Klocke, Fritz, Holland-Letz, Klaus, Würz Timo. “Abschlussbericht.” Technologienetz Trockenbearbeitung. (Article), ISSN 1610-8213, (December 2002)
- ¹¹Lacalle, de Lopez L.N., Angulo*, C., Lamikiz, A., Sanchez, J.A.. “Experimental and Numerical Investigation of The Effect of Spray Cutting Fluids in High Speed Milling.” Journal of Materials Processing Technology. (Article), 172 (2006) 11-15, (August 31, 2005)

¹²<http://www.mmsonline.com/articles/the-many-ways-ford-benefits-from-mal>. The Many Ways Ford Benefits From MQL: Modern Machine Shop, October 1, 2010

¹³Rahman, M., A. Senthil Kumar, S. Manzoor UI. "Evaluation of Minimal Quantities of Lubricant in End Milling." International Journal of Advanced Manufacturing Technology. (Article), 18/4:235-241

¹⁴Liao, Y.S., Lin, H.M., Chen, Y.C.. "Feasibility Study of The Minimum Quantity Lubrication in High-speed End Milling of NAK80 Hardened Steel by Coated Carbide Tool." International Journal of Machine Tools and Manufacture, (Article), 47/11:1667-1676, (2007)

¹⁵Faverjon, Pierre, Rech, "I Joe, Leroy, Rene'. "Influence of Minimum Quantity Lubrication on Friction Coefficient and Work-Material Adhesion During Machining of Cast Aluminum With Various Cutting Tool Substrates Made of Polycrystalline Diamond, High Speed Steel, and Carbides." Journal of Tribology, (Article), Vol. 135, (October 2013)

About this booklet

Note: This author of this booklet is employed by, the work sponsored by, and the booklet is distributed by Unist, Inc. The author has tried to keep the information factual and unbiased, but no doubt some has crept in. The preponderance of the examples, pictures, and specifics using Unist equipment and lubricants is not coincidental.

TECH/Industry/Metalwrk
US \$19.99
UUBIS 8002-53-5462

